

Notice d'installation / Note of installation

Composants / Component

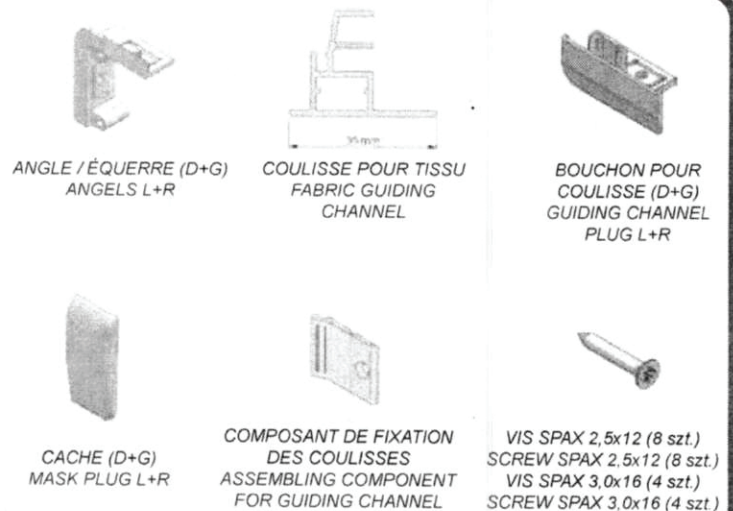
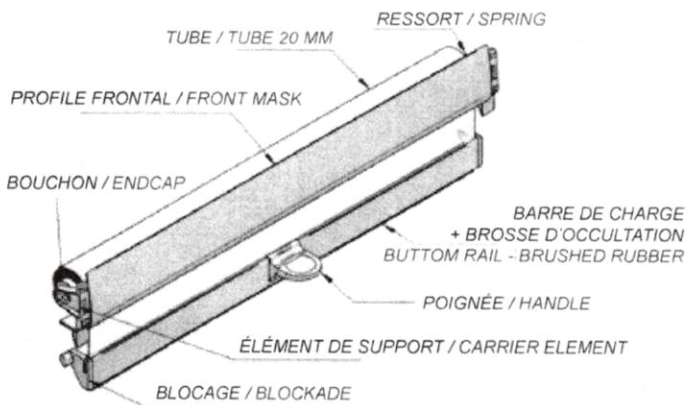

Montage sur fenêtre / Assembly on window

1. Installer les angles (équerres) gauche et droit dans les coin de la fenêtre avec des vis 2,5x12 (figure 1)
Mount left and right angles in the corners of window with screws 2,5x12 (pic.1)
2. Installer les coulisses dans les coin gauche et droit avec des vis 2,5x12 (figure 2)
Mount guiding channel plugs in the right and left corner of window with screws 2,5x12 (pic.2)
3. Installer les coulisses de guidage du tissu, en faisant lentement glisser la partie supérieur de la coulisse sur l'élément de support (figure 3)
Mount fabric guiding channel, by slowly slip upper end of guiding channel onto the carrier element (pic.3)
4. Glisser l'élément de fixation dans la coulisse (figure 4) / Slip assembly component into the guiding channel (pic.4)
5. Installer les éléments de support (blocage) dans la coulisse (figure 5) / Place blockades in to the guiding channel (pic.5)

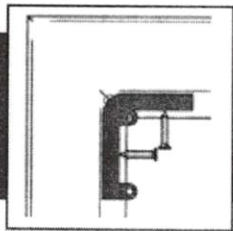

Figure 1 / Picture 1

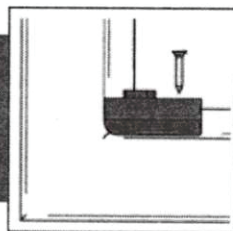

Figure 2 / Picture 2

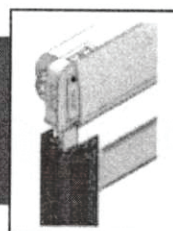

Figure 3 / Picture 3

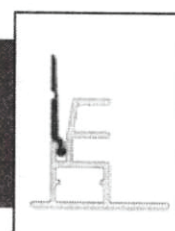

Figure 4 / Picture 4

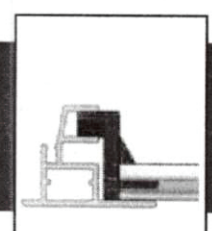

Figure 5 / Picture 5

6. Installer la partie basse de la coulisse sur le bouchon de la coulisse (figure 6)
Place the lower end of guiding channel on the guiding channel plug (pic.6)
7. Fixer le store à la fenêtre en vissant les éléments de support aux angles (équerres) déjà installés (figure 7) avec des vis 3,0x16
Mount roller blind to the window by screwing the carrier elements to already mounted angles (pic.7) with screws 3,0x16
8. Vissez les composants de fixation au contour de la fenêtre avec des vis 2,5x12, au centre de la coulisse
Screw the assembling component to the window frame with screws 2,5x12, in the middle of the guiding channel
9. Mettez le cache (figure 8) / Put mask plugs in (pic.8)

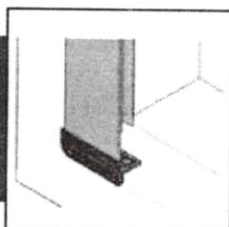

Figure 6 / Picture 6

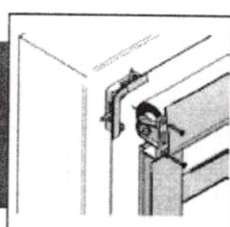

Figure 7 / Picture 7

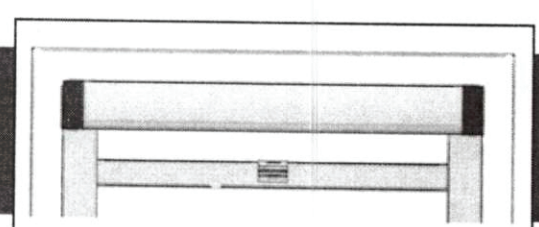

Figure 8 / Picture 8